

Technical Questionnaire

This questionnaire will assist you in planning the implementation of a bar code reading system. (Please copy the form as required)

Date: _____
 Customer Name: _____
 Phone: _____

Company: _____
 Address: _____
 Fax: _____

Branch: _____
 City: _____ State: _____ Zip: _____

APPLICATION NOTES

Description: _____

BAR CODE READING SYSTEM REQUIREMENTS

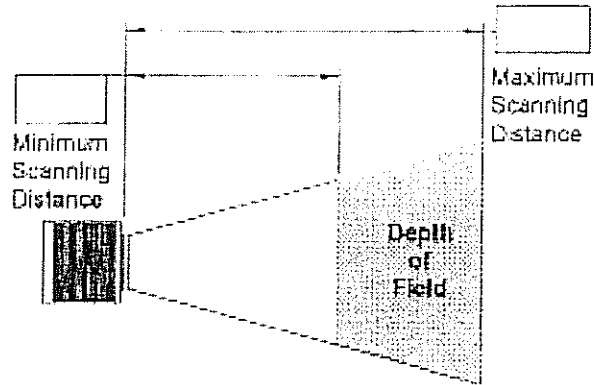

TRANSPORTATION AND CONVEYOR SYSTEM

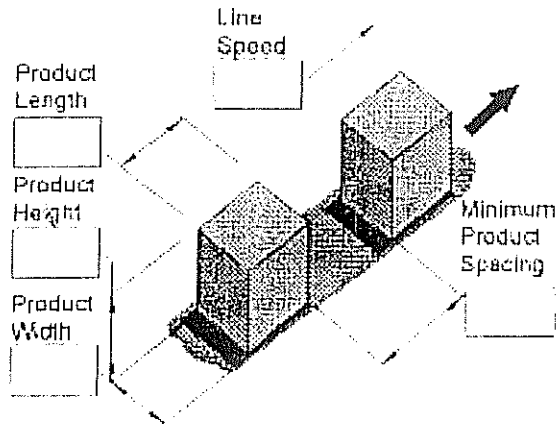

Mark Label Position on Boxes 
 Number of Bar Codes Per Reading Gate

BAR CODE LABEL SPECIFICATIONS

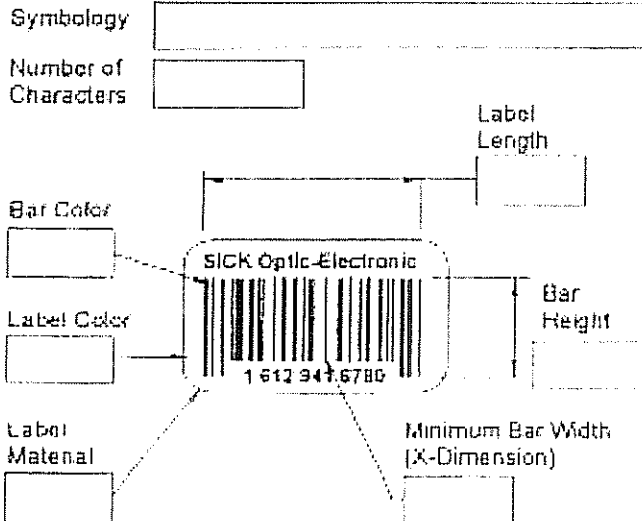

LABEL ORIENTATION

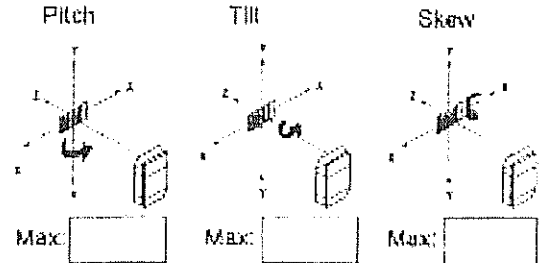
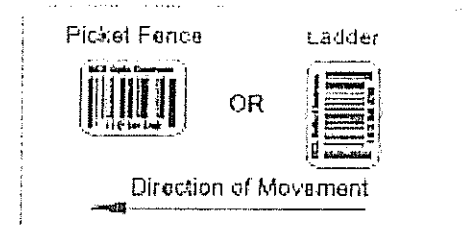

INTERFACE

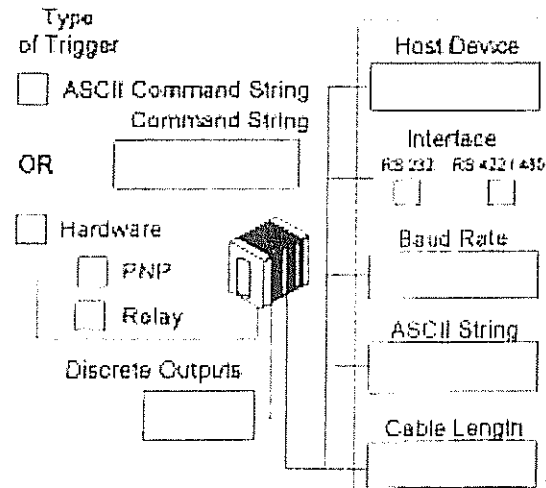

Automatic Identification Systems



Fax Number: (612) 941-9287